

Fig. 11

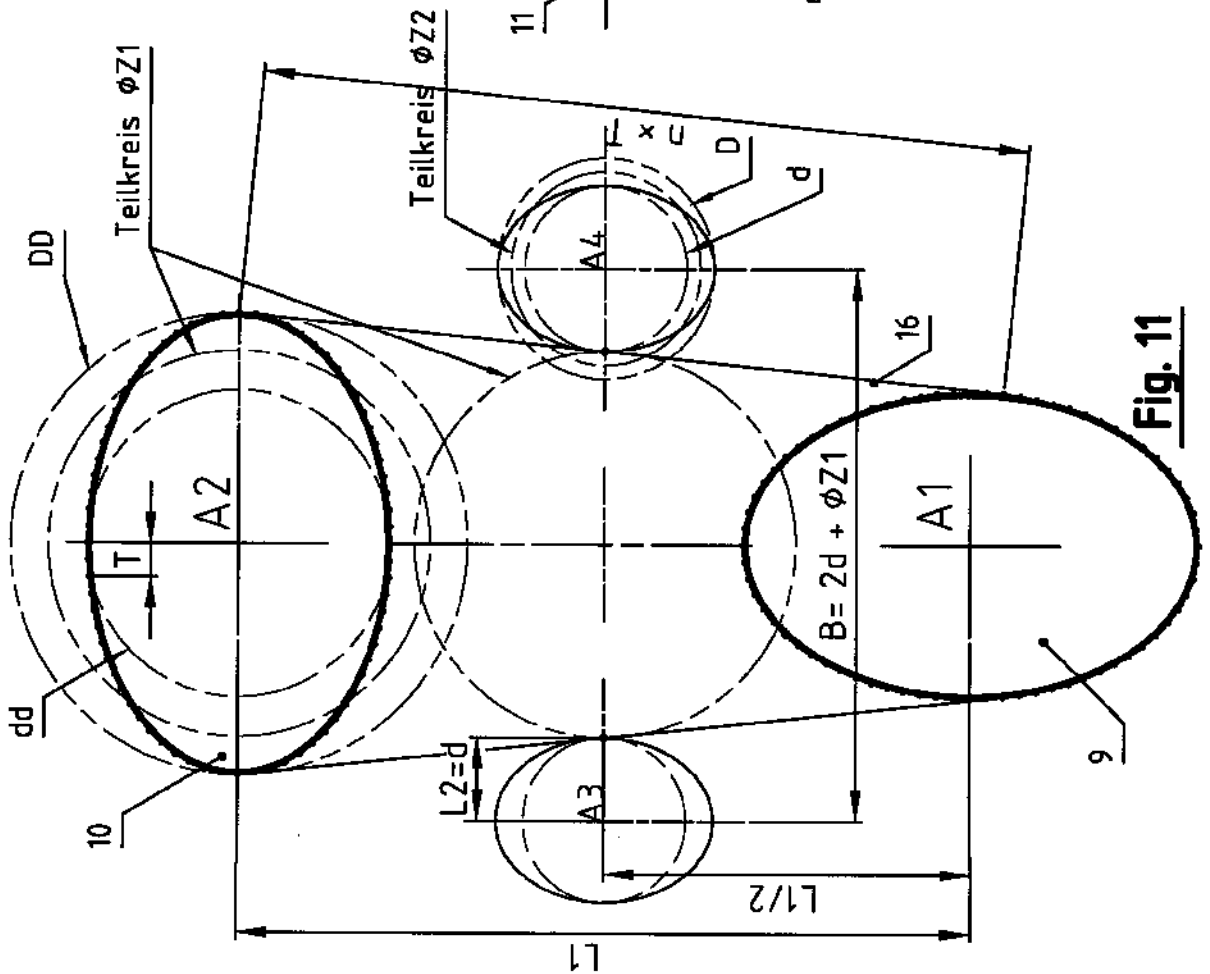

Fig. 12